

DELGARD®

PREMIER ALUMINUM FENCING



Delgard Premier Aluminum Fencing provides an elegant and stately accent to any home or workplace. For almost 20 years, Delgard has offered the traditional beauty of wrought-iron without the costly and time-consuming maintenance required of other fencing systems. Delgard starts with raw aluminum, a special Titanium-bearing alloy and fabricates it into a durable and distinguished product that will accent any home or property. Plus, every Delgard fence features the exclusive **Diamond Kote 10,000™** paint finish and a **limited lifetime warranty** against cracking, chipping, and peeling.

Delgard is available in 7 heights, 5 different colors, and 3 grades, Residential, Aero, and Commercial.

Residential...

Delgard Residential grade is a perfect choice for swimming pool enclosures and perimeter fencing. Matching gates are available in widths of 36", 42", 48", 60" and 72" and feature our **patented self-closing hinges** and the new Versa-Latch or Magna Latch.



Aero...

Delgard's Aero grade provides the comfortable look of Residential fence with added strength and durability. Aero's unique versatility makes this fence a great choice for swimming pool enclosures, estate fencing, golf courses, and housing developments. Matching gates are available in widths of 36", 48", 60", 72", 84" and 96" and feature our **patented self-closing hinges** and the new Versa-Latch or Magna latch.



Commercial...

When you need additional strength and security, turn to Delgard's Commercial fencing system. Parking lots, play centers, manufacturing facilities, and community swimming pools are just a few of the commercial locations that utilize Delgard Commercial grade. Matching swing gates are available in widths of 36", 42", 48", 60" and 72". Larger swing gates and cantilever gates are also available.



Table of Contents...

INTRODUCTION 2

RESIDENTIAL FENCE 3

RESIDENTIAL GATES 6

AERO FENCE 7

AERO GATES 10

COMMERCIAL FENCE 11

COMMERCIAL GATES 14

SPECIALTY GATES 15

DELGARD STORY 21

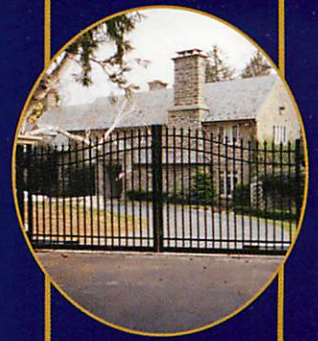
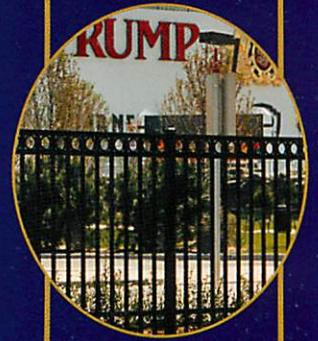
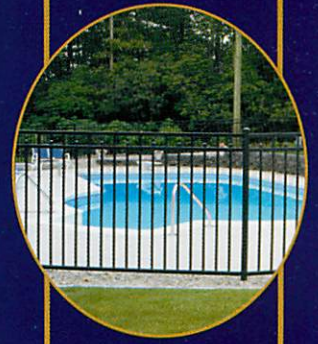

Introduction

With so many styles from which to choose, the easy part is selecting Delgard; the hard part is choosing from all of the beautiful options. To customize your fence, add decorative accessories such as finials, ball caps, scrolls or circles. Use the images below as well as the photos throughout the brochure to determine which combination works best for you. Mix and match...who knew choosing fencing could be so much fun?

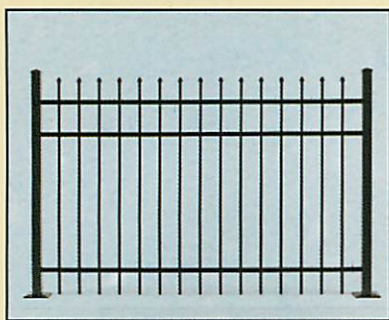

AVALON: Residential, Aero
MADRID: Commercial

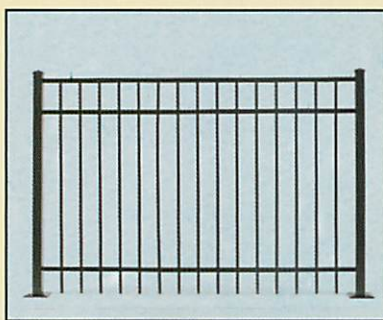

ELBA: Residential, Aero
STRATFORD: Commercial

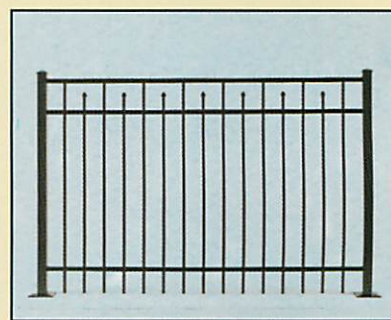

DORIA: Residential, Aero
Laurel: Commercial

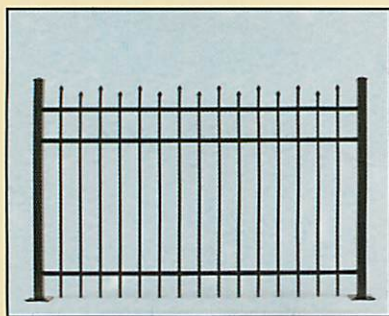

BARCELONA: Residential
TAHOE: Commercial

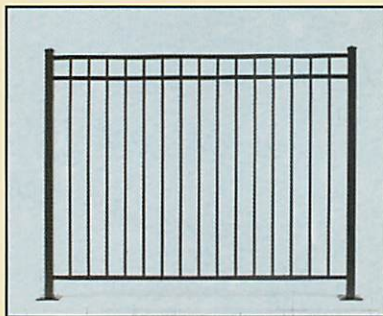

GUARDIAN ELBA:
Residential, Aero

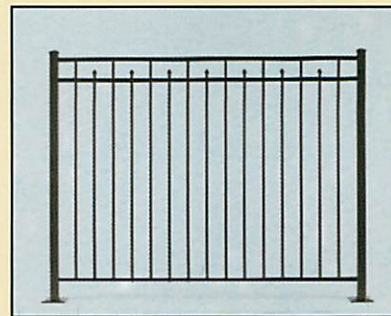

GUARDIAN DORIA:
Residential, Aero

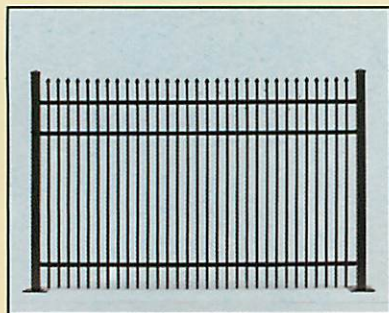

HIALEAH:
Residential

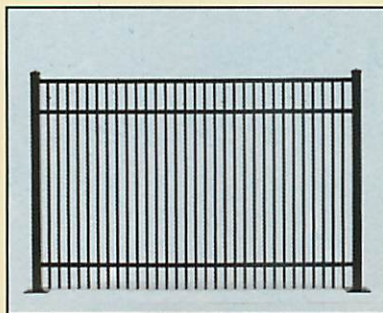

INNSBRUCK:
Residential

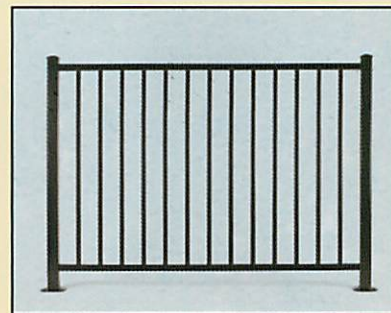

SENTRY:
Aero

Residential.

The residential grade offers the classic look of a narrow picket and horizontal rail. It is best suited for swimming pool enclosures or as decorative perimeter fencing around most homes. To complement your landscape or simply keep your children and pets close to home, this is an ideal choice.

Delgard's Residential grade features 5/8" square pickets, 1" square rails, and 2" square posts. All fence sections come pre-assembled in 6' lengths.



Residential

Styles

Residential Grade comes in a variety of style options, offering the classic look of wrought iron without the costly annual maintenance.



BRONZE RESIDENTIAL AVALON W/BALL CAPS & TRIAD FINIALS



BLACK RESIDENTIAL BARCELONA W/TRIAD FINIALS



WHITE RESIDENTIAL ELBA W/BALL CAPS

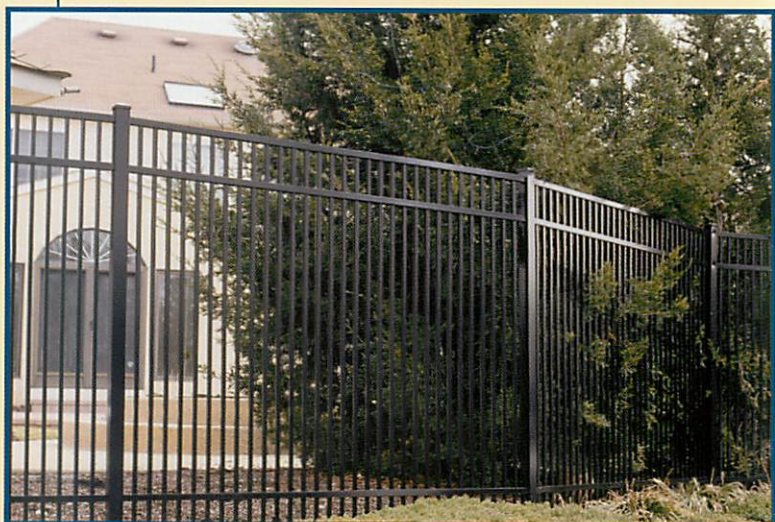

BLACK RESIDENTIAL INNSBRUCK

Residential...

AVAILABLE IN STYLES:

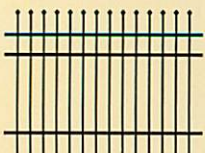

Avalon

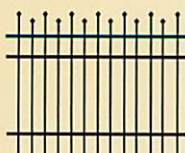

Barcelona

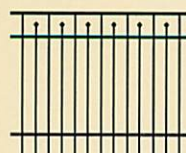

Doria



Elba

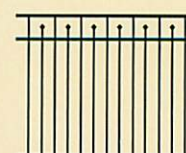

Guardian Doria
(pool code compliant)

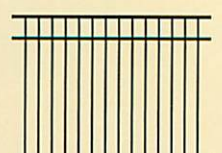

Guardian Elba
(pool code compliant)

The **Guardian Series** has been designed to comply with the stringent ICC pool safety codes. This series offers several styles that provide a dropped bottom rail so that no pickets are exposed.

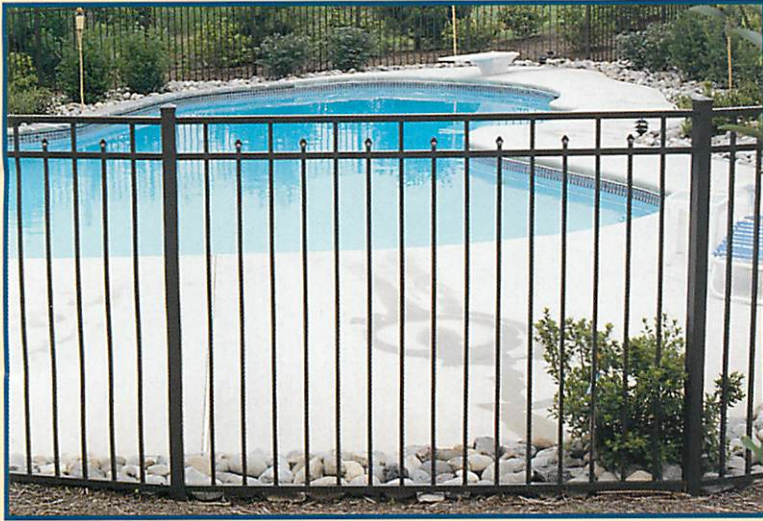

BRONZE RESIDENTIAL GUARDIAN DORIA



BLACK RESIDENTIAL GUARDIAN ELBA

A finishing touch can be added by selecting accessories that will truly customize your fence. In addition to the standard colors, accessories are also available in a rich metallic gold color that provides a truly beautiful finish.

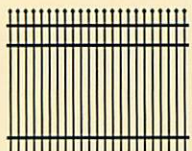

Hialeah

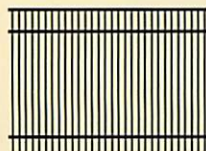

Innsbruck

COLORS:



Black



White



Bronze



Sandstone



Hunter Green

Featured Accessory



Ball Cap



Triad Finial

ACCESSORIES:



Royal Finial



Triad Finial



Standard Cap

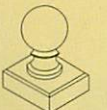

Ball Cap



Estate Scroll

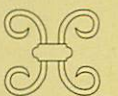

Butterfly Scroll

HEIGHTS:

Available in these heights:

48" 60"

54" 72"

Avalon & Elba also available in:

36" 42"

*54" available in Guardian Series

Residential Gates

All Residential gates are available in matching fence styles and in widths of 36", 42", 48", 60" & 72" in either straight or arch type styles and feature Delgard's **patented self-closing hinges**.



BLACK RESIDENTIAL GUARDIAN DORIA



BLACK RESIDENTIAL ARCH DORIA



BLACK RESIDENTIAL ARCH AVALON W/TRIAD FINIALS

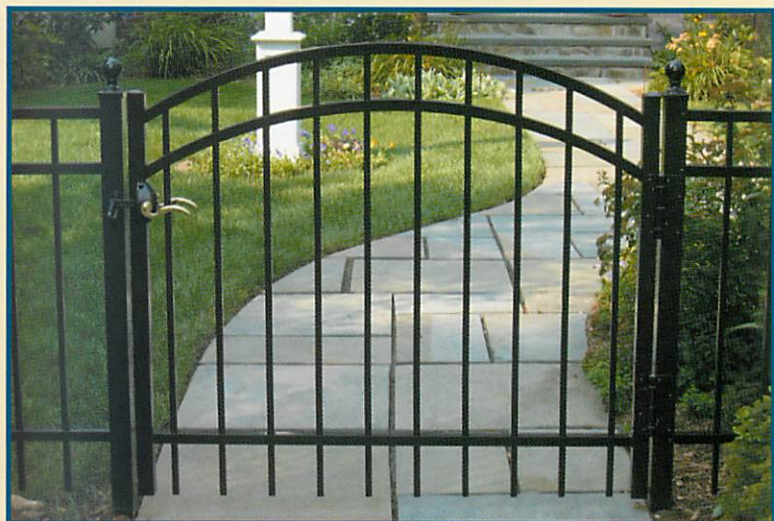

BLACK RESIDENTIAL ARCH ELBA

LATCH ACCESSORIES:

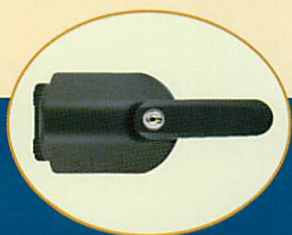

VERSA-LATCH



MAGNA LATCH

HEIGHTS:

Available in these heights:

- 36"
- 42"
- 48"
- 54"
- 60"
- 72"

ACCESSORIES:



Royal Finial



Triad Finial

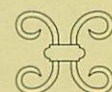

Butterfly Scroll



Estate Scroll

Aero..

Available only from Delgard, Aero has redefined ornamental fencing. When only the best will do, Aero is it. Swimming pool enclosures, estate fencing, golf courses and new home developments are just a few of the many applications where this grade is not only functional, but actually enhances the appearance of the property.

Delgard's Aero grade features 1" x 5/8" rounded pickets, 1 1/2" x 1 1/8" rounded rails, and 2 1/2" rounded posts. All fence sections come pre-assembled.

Aero



Styles

Aero Grade offers beauty, versatility and is recognized for the light appearance of residential grade with much of the strength of our commercial grade. Post spacing is every eight feet for enhanced visibility and easier, less costly installations.



BLACK AERO AVALON w/BALL CAPS & TRIAD FINIALS



SANDSTONE AERO ELBA



BLACK AERO SENTRY



WHITE AERO SENTRY

Aero...

AVAILABLE IN STYLES:

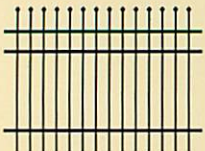

Avalon

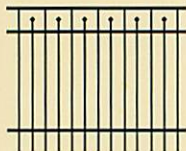

Doria



Elba

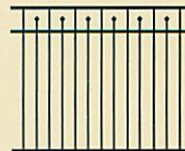

Guardian Doria
(pool code compliant)

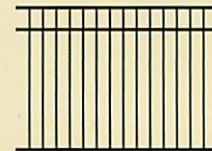

Guardian Elba
(pool code compliant)

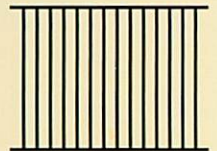

Sentry
(pool code compliant)

All styles are 101" wide panels except Sentry, which has 71" wide panels.

An elegant radius on all pickets, posts, and rails create Aero's graceful soft style. This grade is extremely practical for swimming pool enclosures, estate fencing, golf courses, and new home developments.

Featured Accessory

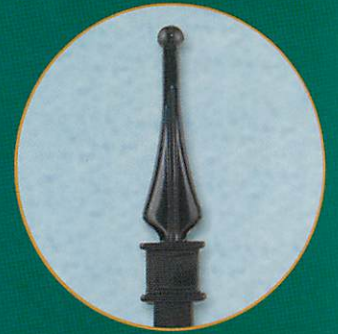

Royal Finial



Circle

COLORS:



Black



White

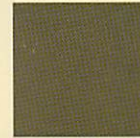

Bronze

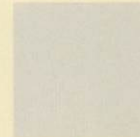

Sandstone



Hunter Green

ACCESSORIES:



Royal Finial



Triad Finial



Standard Cap

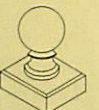

Ball Cap



Estate Scroll



Circle



Butterfly Scroll

HEIGHTS:

Available in these heights:

48"

54"

60"

72"

**54" available in Guardian Series only*

BLACK AERO GUARDIAN ELBA

BLACK AERO GUARDIAN DORIA

Black, white, bronze, sandstone or hunter green. Express your creativity and sense of style with any of the color options. Pick a color that best suits your taste, or the choice that matches your home color scheme.

Aero Gates

All Aero gates are available in matching fence styles and in widths of 36", 48", 60", 72", 84" & 96" in either straight or arch type styles and feature Delgard's **patented self-closing hinges**.



BLACK AERO DORIA



BLACK AERO ARCH DORIA



BLACK AERO ARCH AVALON



SANDSTONE AERO ARCH ELBA

LATCH ACCESSORIES:

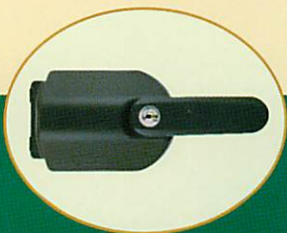

VERSA-LATCH

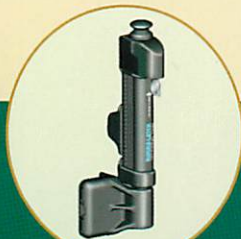

MAGNA LATCH

HEIGHTS:

Available in these heights:

48"

54"

60"

72"

ACCESSORIES:



Royal Finial



Triad Finial



Circle

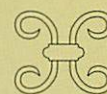

Butterfly Scroll



Estate Scroll

Commercial..

Commercial

*F*or high traffic areas, public facilities and large residential properties where security, aesthetics and superior strength are most important, choose Delgard's Commercial-grade fencing. By combining strength and beauty, Delgard commercial grade can achieve your enclosure requirements with style.

Delgard's Commercial-grade features 1" square pickets, 1 5/8" square rails, and 2 1/2" square posts. All fence sections come pre-assembled.



Styles

Unlike other fencing options such as steel, which will ultimately rust regardless of coatings; wood, which will begin to discolor and decay soon after installation; and plastic (PVC), which is only available in limited colors;



BLACK COMMERCIAL MADRID WITH BALL CAPS



BLACK COMMERCIAL TAHOE



HUNTER GREEN COMMERCIAL MADRID



HUNTER GREEN COMMERCIAL STRATFORD

Commercial...

AVAILABLE IN STYLES:

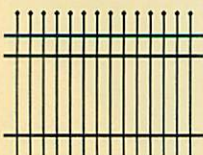

Madrid

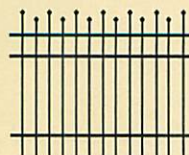

Tahoe

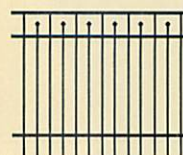

Laurel

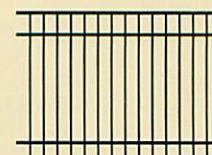

Stratford

Delgard represents the obvious choice. It is consistently selected by architects, landscape architects and municipalities.



BLACK COMMERCIAL STRATFORD WITH CIRCLES

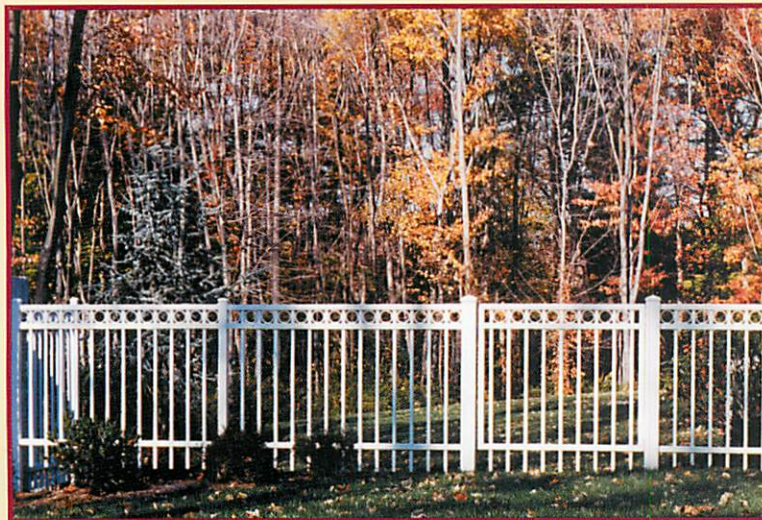

WHITE COMMERCIAL STRATFORD WITH CIRCLES

Delgard fence is manufactured from a special Titanium-bearing aluminum alloy that offers high strength, combined with the natural properties of aluminum, which means it cannot rust. The **Diamond Kote 10,000™** paint finish that is applied, has been used, improved and perfected by Delgard over the last forty years.

COLORS:



Black



White



Bronze



Sandstone



Hunter Green

Featured Accessory



Royal Cap



Butterfly Scroll

ACCESSORIES:



Royal Finial



Triad Finial



Standard Cap

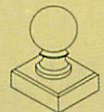

Ball Cap



Royal Cap



Estate Scroll



Circle

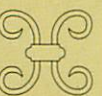

Butterfly Scroll

HEIGHTS:

Available in these heights:

48"

60"

72"

96"

Commercial Gates

All Commercial gates are available in matching fence styles and in widths of 36", 42", 48", 60" & 72".
Larger swing gates and cantilever gates are also available.



BLACK COMMERCIAL MADRID WALK GATE



WHITE COMMERCIAL STRATFORD WALK GATE W/CIRCLES



BLACK COMMERCIAL ARCH MADRID DRIVE GATE W/ROYAL FINIALS

LATCH ACCESSORIES:

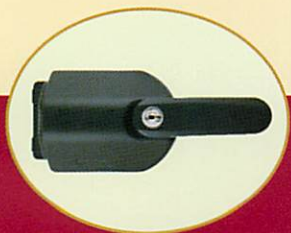

VERSA-LATCH



MAGNA LATCH

HEIGHTS:

Available in these heights:

48"
60"
72"
96"

ACCESSORIES:



Royal Finial

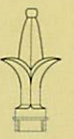

Triad Finial



Circle

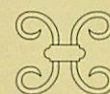

Butterfly Scroll



Estate Scroll

Specialty Gates..

Delgard's Specialty Gates are a perfect way to highlight your property or landscape. With a full selection of high-style gates, from classic to modern, there is sure to be an arched gate to fit your needs. In addition, our commercial gates are compatible with most gate operating systems, so they can be operated remotely from a central location, adding increased security.



Specialty Gates

Cantilever Gates

For almost 20 years, Delgard has been a leader in ornamental maintenance free aluminum fencing. Delgard continues its tradition of innovation with its new and improved cantilever gate system. The Delgard Design Team listened to many contractors around the country and performed hours of field research to come up with its innovative and effective system.

This system boasts a free form design that allows multiple styling options including availability of arch top and estate styles. The unique styling of the gate gives it the traditional look of a classic wrought iron double swing gate. However, not everything is about looks with this system. The gate utilizes an innovative bottom support track that lowers the center of gravity providing greater stability and ease of motion. Delgard's modular design also allows for ease of transportation and quick on-site installation.

Innovation, strength, ease of installation, durable and smooth operation, plus Delgard's standard of beauty make Delgard's cantilever gate system unsurpassed in the industry.



BRONZE MADRID ESTATE CANTILEVER GATE

Modular design

- Modular design makes transportation to the job site easy
- Modular design and simplified assembly allows for quick on-site installation with much smaller crews than traditional cantilever gates
- Innovative design allows for single gate opening up to 30 feet

Solid Construction

- All structural elements are built from 6061-T6 alloy aluminum which carries nearly double the yield strength of 6063-T5 alloy aluminum (the industry accepted standard for Aluminum Cantilever gate material)
- All moving hardware is located on the back side of the gate reducing front facing pinch-points and allowing greater flexibility when installing behind existing structures
- Bottom support track lowers center of gravity providing greater stability and ease of motion
- Enclosed guide wheel track protects rubber guide wheels from elements and reduces pinch points
- Adjustable truss support system allows for field calibration

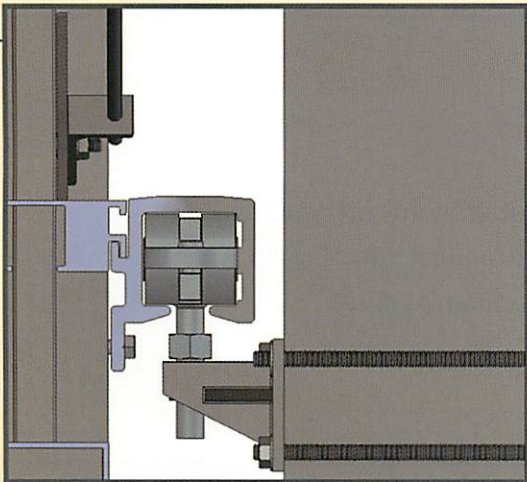

BOTTOM SUPPORT RAIL (CUT-AWAY VIEW)

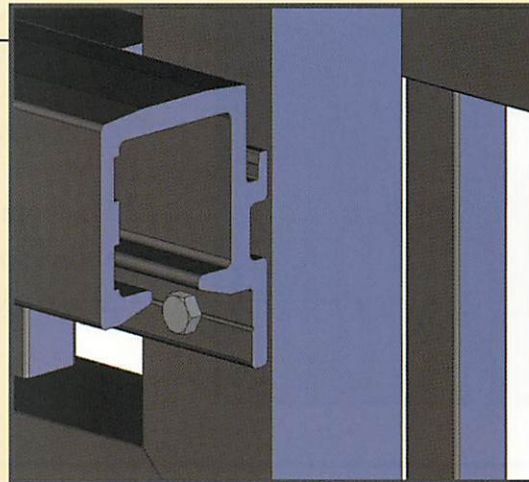

BOTTOM SUPPORT RAIL

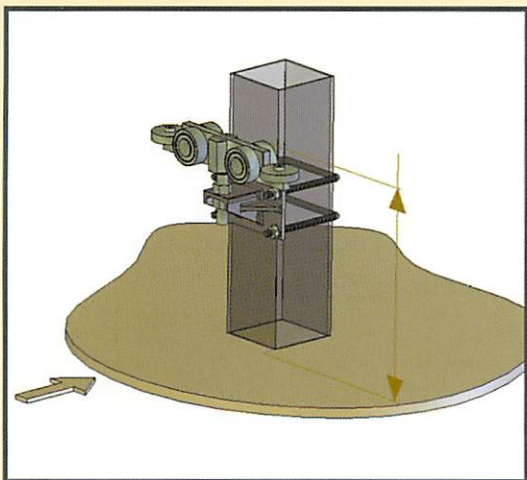

SUPPORT RAIL WHEEL ASSEMBLY

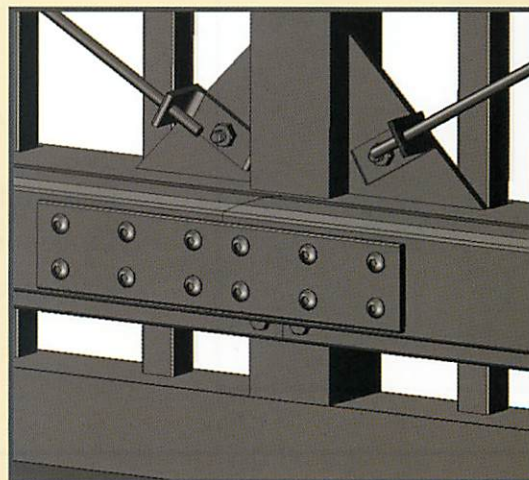

TRUSS SUPPORTS

Arched Gates

All Residential and Aero grade gates are available with an arch top. Commercial grade gates are available with an arch top or an estate curve.



MADRID ESTATE CURVE

Madrid Estate

One of our most popular gates in the Delgard Arched Series. The Madrid Estate's magnificent craftsmanship will create a truly impressive welcome to your property.



MADRID ARCH

Madrid Arch

The combination of graceful intricacies and clean lines distinguish the Madrid Arch as a truly elegant entrance gate.

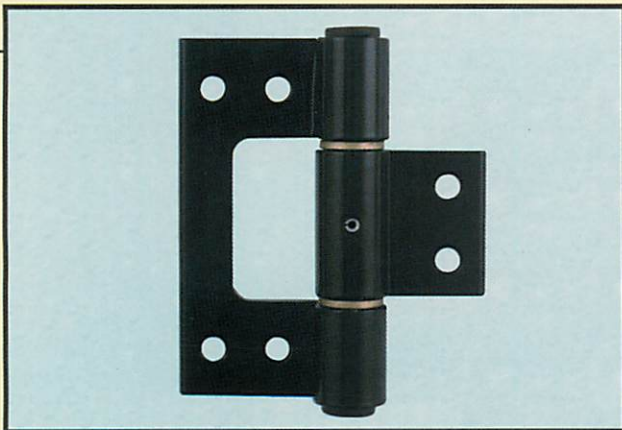

HEAVY-DUTY BARREL HINGE

Heavy-Duty Barrel Hinge

Delgard has designed its new Heavy-duty Barrel Hinge for smooth operation and increased weight load capacity for all of our bigger gates.

Delgard Premier Gates

The Premier Gate Series offers several options to make an entrance or walkway sensational. Fabricated of heavy-duty aluminum extrusions and castings, and offering total welded construction, these gates can be mounted to any type of post or column, and will easily handle a gate operator.

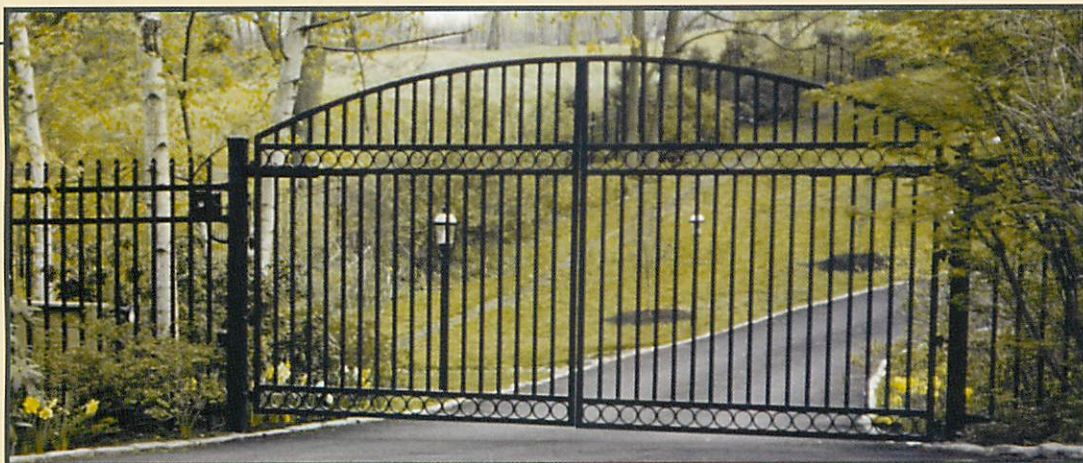

ARDMORE GATE



DELRAY GATE

COLORS:



Black



White



Bronze

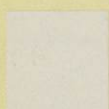

Sandstone



Hunter Green

HEIGHTS:

Any Height from
48" to 96"

ACCESSORIES:

Standard Delray Gates come with 7/8" Round Pickets.

Our Residential and Aero grade pickets are available as an option.

The Delgard Difference



Paint Finish

Only Delgard uses the exclusive **Diamond Kote 10,000™** paint finish that has a limited lifetime warranty not to crack, chip or peel. This environmentally safe process includes some Delgard secrets that have been improved over time, and the steps include:

- High Alkaline cleaner that prepares the surface and then
- A fluoride based, acidic process to further condition and clean the material, and finally an
- Application of a polymer primer that promotes adhesion and inhibits corrosion.

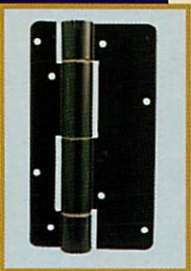

Gate Hinge

Delgard has designed and manufactured a **patented self-closing hinge** that is the envy of the fence industry. Each hinge is made with an adjustable spring in a durable yet slim wrap-around design to ensure years of reliable closing.

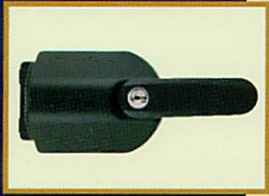

New Versa-Latch

The new Versa-Latch is another first-of-a-kind innovation from Delgard and its long-time partner, the makers of the Magna Latch. The Versa-Latch features a magnetically activated mechanism in addition to a keyed lock for even more security. This low friction latch is more reliable, self-latching and highly effective. The Versa-Latch now comes standard with all of Delgard's walk gates except Guardian Series which uses the Magna Latch.

Gate Specifications

Delgard has completely redesigned its gates using more aluminum and stronger alloys. These redesigned gates are now 300% stronger for even better durability and stability.

	<i>Residential</i>	<i>Zero</i>	<i>Commercial</i>
Framework	1½" x 1½" x .125"	2½" x 2½" x .125"	2½" x 2½" x .125" Up to 96" opening
			3" x 3" x .125" Over 96" opening
Alloys	6061-T6	6061-T6	6061-T6
U-Frame Strengtheners	Over 60" opening	Over 60" opening	Over 60" opening
Standard Latch	Versa-Latch	Versa-Latch	Versa-Latch – up to 96" leaf
	Magna Latch (Guardian Series Only)	Magna Latch (Guardian Series Only)	Lokk Latch – greater than 96" leaf
Hinges	36" wide thru 72" wide Self Closing	36" wide thru 60" wide Self Closing	36" wide thru 60" wide Self Closing
		72" wide thru 96" wide Barrel	72" wide thru 192" wide Barrel

The Delgard Story













Delgard has been the leader in maintenance-free ornamental aluminum fencing for almost 20 years. In that time, Delgard has continuously improved its products and manufacturing operations to deliver the industry's best products that will add beauty, security and value to any property.

Delgard's quality starts from the very beginning of the fence making process, the aluminum. You see, Delgard is part of the Arch America family of companies, a group that has been manufacturing high quality aluminum and building products for over 40 years. This relationship ensures that Delgard has a dedicated and unlimited supply of raw aluminum. In fact, **Delgard is the only aluminum fence manufacturer in the world capable of extruding its own aluminum.** Rest assure, you'll never have to worry about material shortages, and your products will always ship on time. In fact, Delgard offers several popular styles in its **Quick Ship Program.** No other manufacturer offers a program as extensive as Delgard's.





















Our global alliances through the Arch America companies have helped to expand our production and sourcing capabilities to Europe, Asia and even Australia. The Delgard team's global reach means that your products are made to our exacting standards.

If you're looking to enclose your swimming pool, enhance your property or secure an area, choose Delgard for the ultimate combination of strength, beauty, and durability. From its commitment to total customer satisfaction, to innovative designs, Delgard is the finest fence available. To learn more about Delgard, visit their website at www.delgard.com.



	RESIDENTIAL	AERO	COMMERCIAL
PICKET	 5/8" x 5/8" x .050" wall thickness	 1" x 5/8" x .050" wall thickness	 1" x 1" x .065" wall thickness
RAIL	 1" x 1" x .055" top wall thickness .080" side wall	 1 1/2" x 1 1/8" x .060" top wall .070" side wall	 1 5/8" x 1 5/8" x .070" top wall .100" side wall
POST	 2" x 2" x .060" wall thickness	 2 1/2" x 2 1/2" x .060" wall thickness .100" power corner	 2 1/2" x 2 1/2" x .075" wall thickness
GATE POST	 2" x 2" x .125" wall thickness	 2 1/2" x 2 1/2" x .125" wall thickness	 4" x 4" x .125" wall thickness 6" x 6" x .188" wall thickness
SPACING	3 13/16" between pickets 1 39/64" (Hialeah & Innsbruck)	3 31/32" between pickets	3 31/32" between pickets
INSTALLED CENTERS	72 3/4" on center 2" posts	100 13/16" on center (2 1/2" posts) 71" on center Sentry (2 1/2" posts)	71" on center 2 1/2" posts
HEIGHTS	36", 42", 48", 54", 60", 72"	48", 54", 60", 72"	48", 60", 72", 96"
COLORS	white, black, bronze, hunter green, sandstone	white, black, bronze, hunter green, sandstone	white, black, bronze, hunter green, sandstone
HORIZONTAL RAILS	3 on 36", 42", 48", 54", 60" 4 on 72"	2 on 48" Sentry 3 on 48", 54", 60" 4 on 72"	3 on 48", 60", 72" 4 on 96"
ALLOY	6063-T5 on pickets 6061-T6 on posts and rails	6063-T5 on pickets 6061-T6 on posts and rails	6063-T5 on pickets 6061-T6 on posts and rails
STRENGTHS	over 350 lbs.	over 350 lbs.	over 1,100 lbs.

ACCESSORIES

	RESIDENTIAL	AERO	COMMERCIAL
PICKET	 Royal Finial  Triad Finial	 Royal Finial  Triad Finial	 Royal Finial  Triad Finial
POST	 Standard Cap  Ball Cap	 Standard Cap  Ball Cap	 Standard Cap  Ball Cap  Royal Finial Cap
SCROLLS	 Butterfly Scroll  Estate Scroll	 Butterfly Scroll  Estate Scroll  Circle (Installed)	 Butterfly Scroll  Estate Scroll  Circle (Installed)

All specifications are subject to change without notice.

DELGARD
PREMIER ALUMINUM FENCING

8600 River Road, Delair, New Jersey 08110
Phone: 1-800-235-0185 • Fax: 856-663-1297
www.delgard.com

AFA American
Fence
Association